

1200V/5A

SiC Schottky Barrier Diode

Characteristic

- Zero Reverse Recovery Current
- Positive temperature coefficient
- Temperature-independent performance
- High-speed switching
- Low switching loss
- Low heat dissipation requirements

Application

- Switching power supply
- Power factor correction
- Motor drive, traction
- Charging pile

Product Description

$V_{RRM}$	1200	V
$I_F(135^\circ\text{C})$	10	A
$Q_C$	28	nC

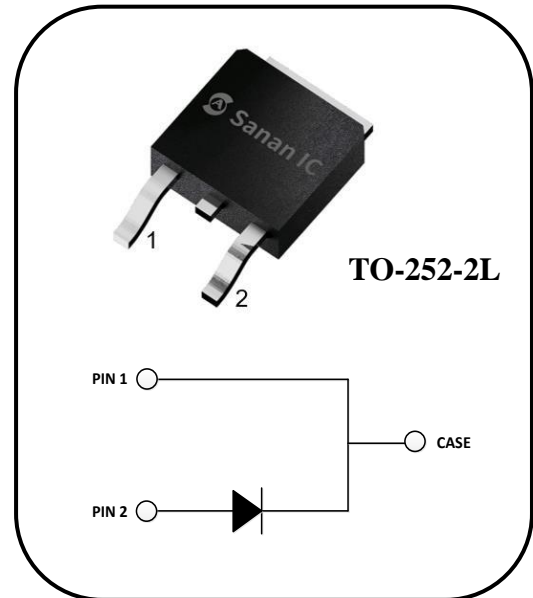

Device	Package	Marking
SDS120J005D3	TO-252-2L	DS120005D3

Absolute Maximum Ratings

Parameter	Symbol	Value	Unit	Test Conditions
Reverse voltage (Repetitive peak)	$V_{RRM}$	1200	V	$T_C=25^\circ\text{C}$
Reverse Voltage (Surge peak)	$V_{RSM}$	1200		$T_C=25^\circ\text{C}$
Reverse voltage (DC)	$V_{DC}$	1200		$T_C=25^\circ\text{C}$
Continuous forward current	$I_F$	22	A	$T_C=25^\circ\text{C}$
		10		$T_C=135^\circ\text{C}$
		5		$T_C=155^\circ\text{C}$
Surge non-repetitive forward current	$I_{FSM}$	55	A	$T_C=25^\circ\text{C}, t_p=10\text{ms}, \text{half Sine Pulse}$
Repetitive Peak Forward Surge Current	$I_{FRM}$	40	A	$T_C=25^\circ\text{C}, t_p=10\text{ms}, \text{half Sine Wave } D=0.1$
Total power dissipation	$P_{TOT}$	134	W	$T_C=25^\circ\text{C}$
$i^2t$ value	$\int i^2 dt$	15	$\text{A}^2\text{s}$	$T_C=25^\circ\text{C}, t_p=10\text{ms}$
Operating temperature	$T_j$	-55~175	$^\circ\text{C}$	
storage temperature	$T_{stg}$	-55~175	$^\circ\text{C}$	

### Thermal Characteristics

Parameter	Symbol	Values			Unit	Test Condition
		Min.	Typ.	Max.		
Thermal resistance	$R_{th(j-c)}$	/	1.12	/	$^{\circ}C/W$	

### Electrical Characteristics $T_j=25^{\circ}C$

Parameter	Symbol	Values			Unit	Test Condition
		Min.	Typ.	Max.		
DC blocking voltage	$V_{DC}$	1200	/	/	V	$I_R=100\ \mu A$
Forward voltage	$V_F$	/	1.35	1.50	V	$I_F=5A, T_j=25^{\circ}C$
		/	1.85	2.20		$I_F=5A, T_j=175^{\circ}C$
Reverse current	$I_R$	/	1	20	$\mu A$	$V_R=1200V, T_j=25^{\circ}C$
		/	3	80		$V_R=1200V, T_j=175^{\circ}C$
Total capacitance	C	/	400	/	pF	$V_R=0V, f=1MHz$
		/	27	/		$V_R=400V, f=1MHz$
		/	20	/		$V_R=800V, f=1MHz$
Total capacitive charge	$Q_C$	/	28	/	nC	$V_R=800V$
Capacitance Stored Energy	$E_C$	/	8.2	/	$\mu J$	$V_R=800V$

### Typical Electrical Characteristics Curves

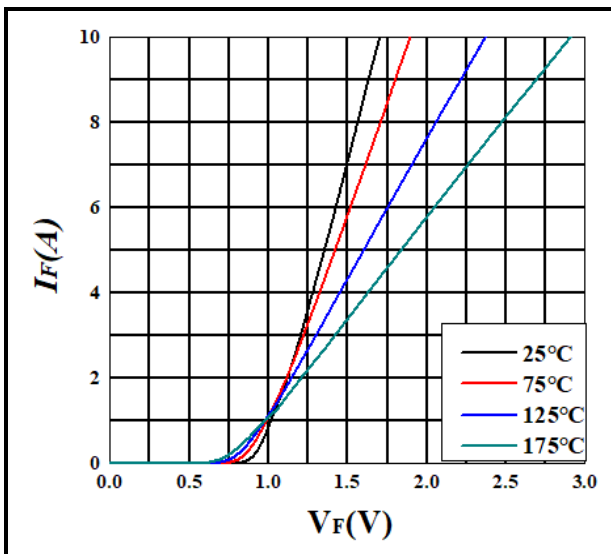

Figure 1. Forward Characteristics

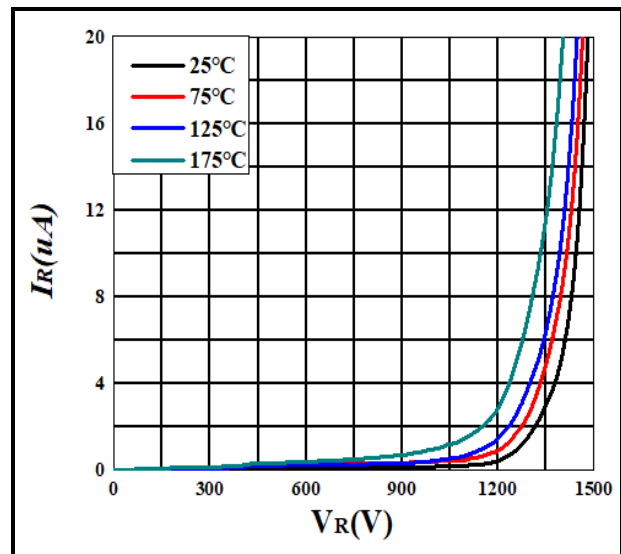

Figure 2. Reverse Characteristics

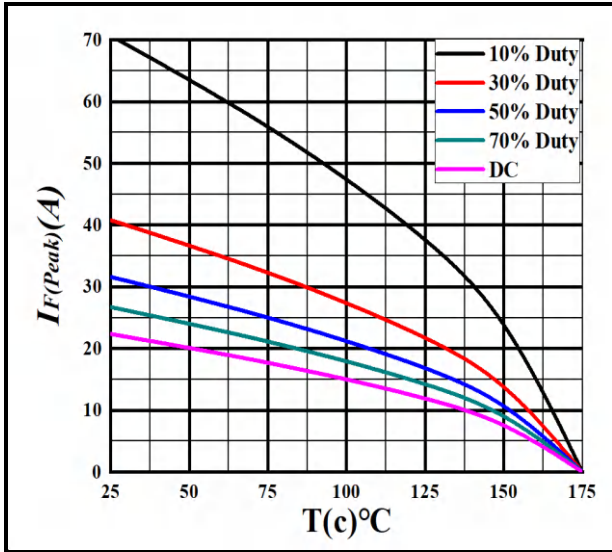

Figure 3. Current Derating

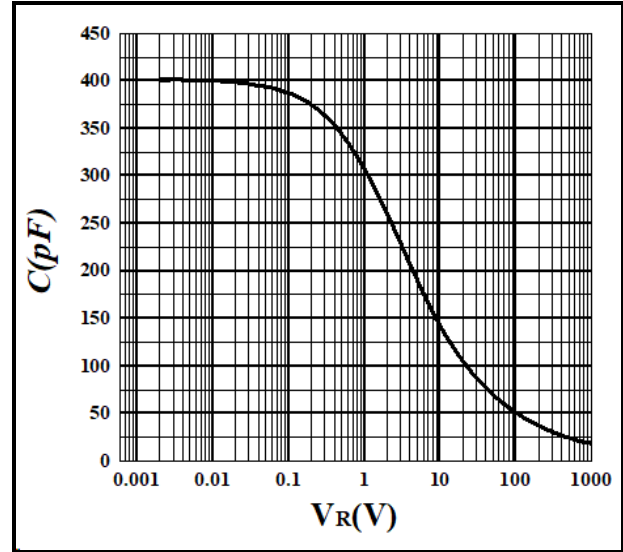

Figure 4. Capacitance vs. Reverse Voltage

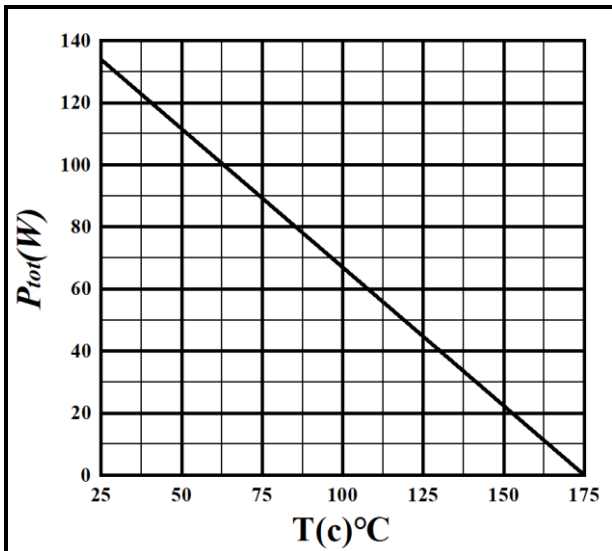

Figure 5. Power Derating

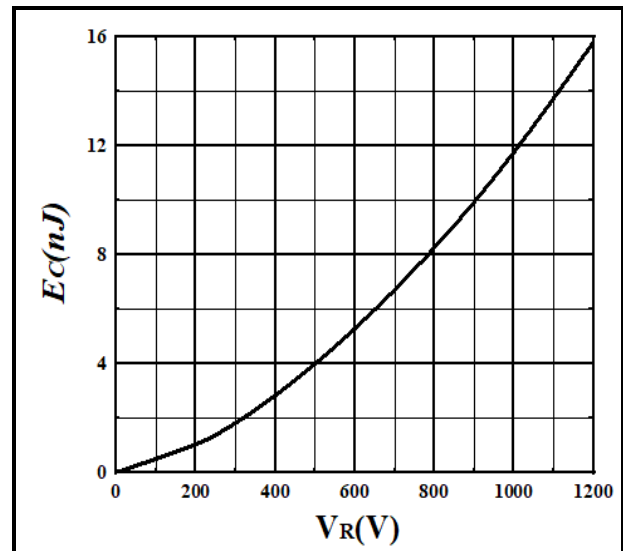

Figure 6. Capacitance Stored Energy

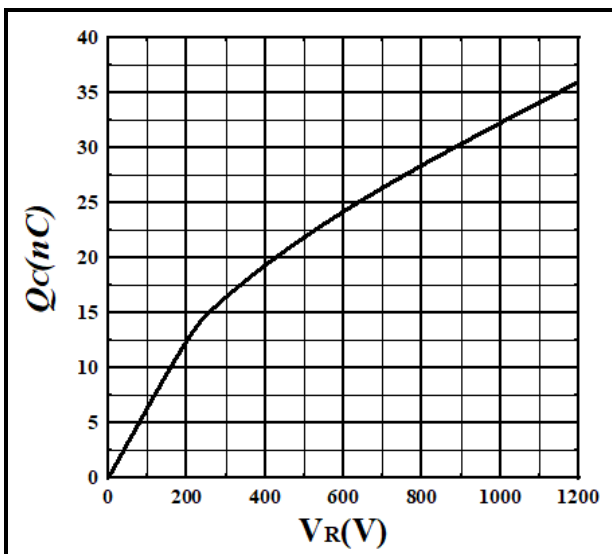
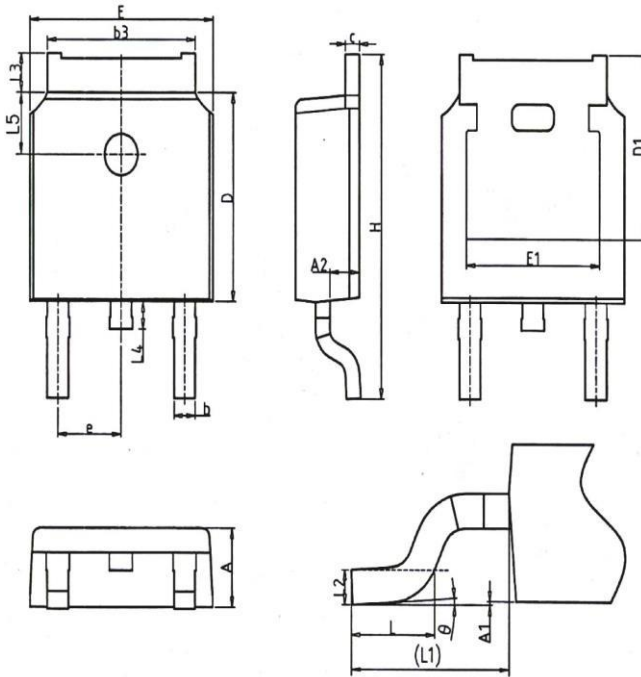

Figure 7. Total Capacitance Charge vs. Reverse Voltage

## Package



SYMBOL	mm		
	MIN	NOM	MAX
A	2.2	2.3	2.38
A1	0	-	0.2
A2	0.97	1.07	1.17
b	0.68	0.78	0.9
b3	5.2	5.33	5.46
c	0.43	0.53	0.61
D	5.98	6.1	6.22
D1	5.30REF		
E	6.4	6.6	6.73
E1	4.63	-	-
e	2.286BSC		
H	9.4	10.1	10.5
L	1.38	1.5	1.75
L1	2.90REF		
L2	0.51BSC		
L3	0.88	-	1.28
L4	0.5	-	1
L5	1.65	1.8	1.95
θ	0°	-	8°

## Ordering information

Part Number	SDS120J005D3-ISARH
Package	TO-252-2L
Unit Quantity	2500 EA
Packing Type	Tape Reel
RoHS	Yes