

1200V/5A

SiC Schottky Barrier Diode

Characteristic

- Zero Reverse Recovery Current
- Positive temperature coefficient
- Temperature-independent performance
- High-speed switching
- Low switching loss
- Low heat dissipation requirements

Application

- Switching power supply
- Power factor correction
- Motor drive, traction
- Charging pile

Product Description

$V_{RRM}$	1200	V
$I_F(135^\circ\text{C})$	8.4	A
$Q_C$	27	nC

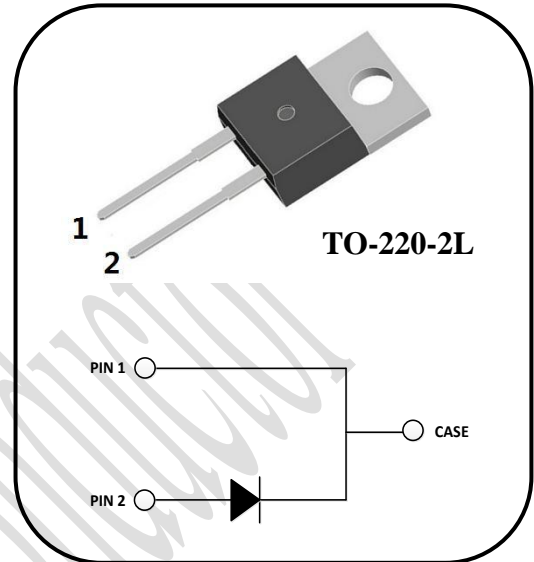

Device	Package	Marking
SDS120J005C2	TO-220-2L	DS120005C2

Absolute Maximum Ratings

Parameter	Symbol	Value	Unit	Test Conditions
Reverse voltage (Repetitive peak)	$V_{RRM}$	1200	V	$T_C=25^\circ\text{C}$
Reverse Voltage (Surge peak)	$V_{RSM}$	1200		$T_C=25^\circ\text{C}$
Reverse voltage (DC)	$V_{DC}$	1200		$T_C=25^\circ\text{C}$
Continuous forward current	$I_F$	18	A	$T_C=25^\circ\text{C}$
		8.4		$T_C=135^\circ\text{C}$
		5		$T_C=155^\circ\text{C}$
Surge non-repetitive forward current	$I_{FSM}$	55	A	$T_C=25^\circ\text{C}, t_p=10\text{ms}, \text{half Sine Pulse}$
Repetitive Peak Forward Surge Current	$I_{FRM}$	33	A	$T_C=25^\circ\text{C}, t_p=10\text{ms}, \text{half Sine Wave } D=0.1$
Total power dissipation	$P_{TOT}$	93	W	$T_C=25^\circ\text{C}$
$i^2t$ value	$\int i^2 dt$	15	$\text{A}^2\text{s}$	$T_C=25^\circ\text{C}, t_p=10\text{ms}$
Operating temperature	$T_j$	-55~175	$^\circ\text{C}$	
storage temperature	$T_{stg}$	-55~175	$^\circ\text{C}$	
Mounting Torque	M	1	Nm	M3 Screw

### Thermal Characteristics

Parameter	Symbol	Values			Unit	Test Condition
		Min.	Typ.	Max.		
Thermal resistance	$R_{th(j-c)}$	/	1.6	/	$^{\circ}\text{C/W}$	

### Electrical Characteristics $T_j=25^{\circ}\text{C}$

Parameter	Symbol	Values			Unit	Test Condition
		Min.	Typ.	Max.		
DC blocking voltage	$V_{DC}$	1200	/	/	V	$I_R=100\ \mu\text{A}$
Forward voltage	$V_F$	/	1.40	1.80	V	$I_F=5\text{A}, T_j=25^{\circ}\text{C}$
		/	2.00	2.70		$I_F=5\text{A}, T_j=175^{\circ}\text{C}$
Reverse current	$I_R$	/	1	15	$\mu\text{A}$	$V_R=1200\text{V}, T_j=25^{\circ}\text{C}$
		/	2	100		$V_R=1200\text{V}, T_j=175^{\circ}\text{C}$
Total capacitance	C	/	353	/	pF	$V_R=0\text{V}, f=1\text{MHz}$
		/	26	/		$V_R=400\text{V}, f=1\text{MHz}$
		/	20	/		$V_R=800\text{V}, f=1\text{MHz}$
Total capacitive charge	$Q_C$	/	27	/	nC	$V_R=800\text{V}$
Capacitance Stored Energy	$E_C$	/	7.9	/	$\mu\text{J}$	$V_R=800\text{V}$

### Typical Electrical Characteristics Curves

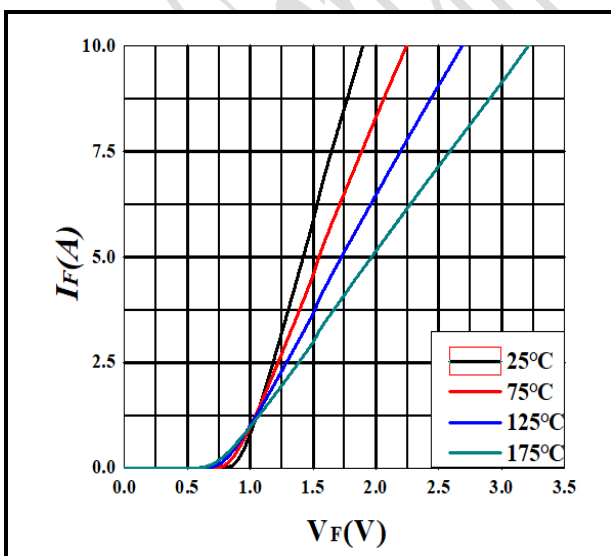

Figure 1. Forward Characteristics

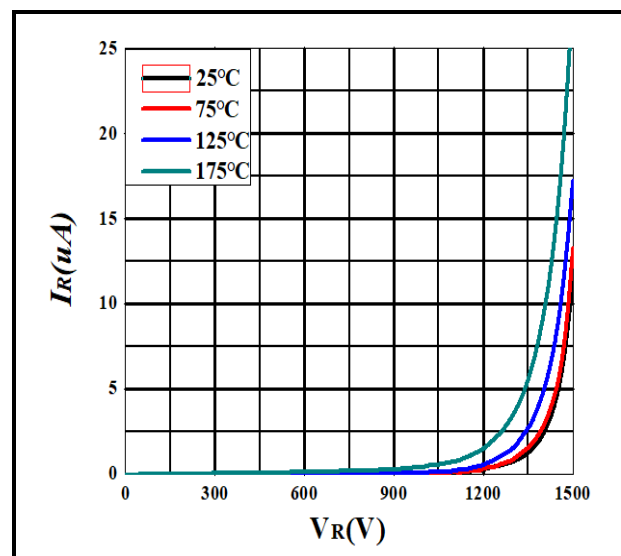

Figure 2. Reverse Characteristics

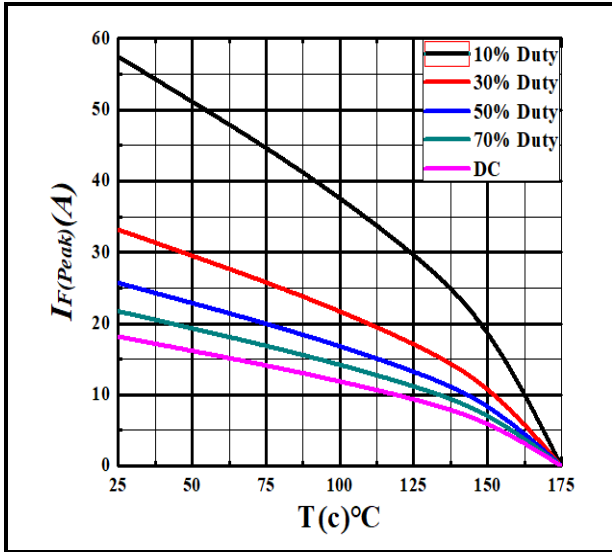

Figure 3. Current Derating

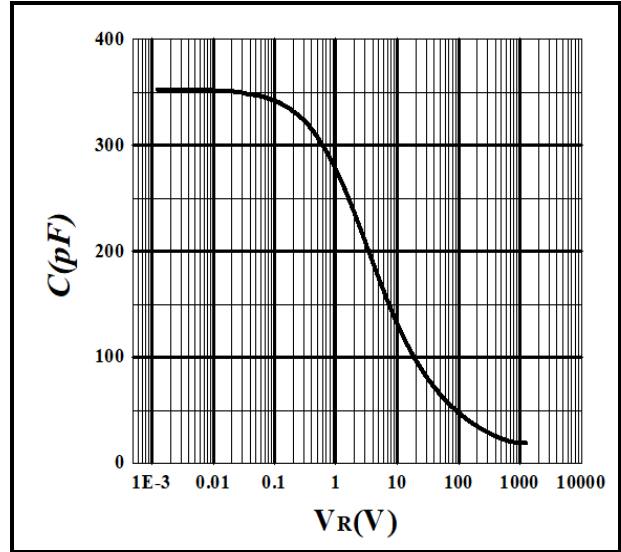

Figure 4. Capacitance vs. Reverse Voltage

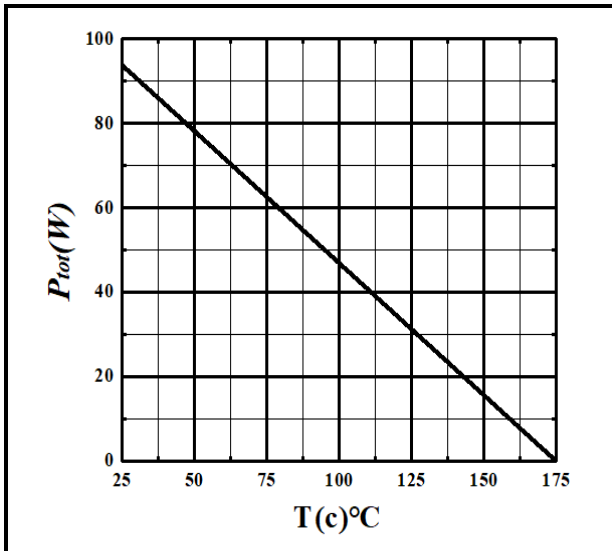

Figure 5. Power Derating

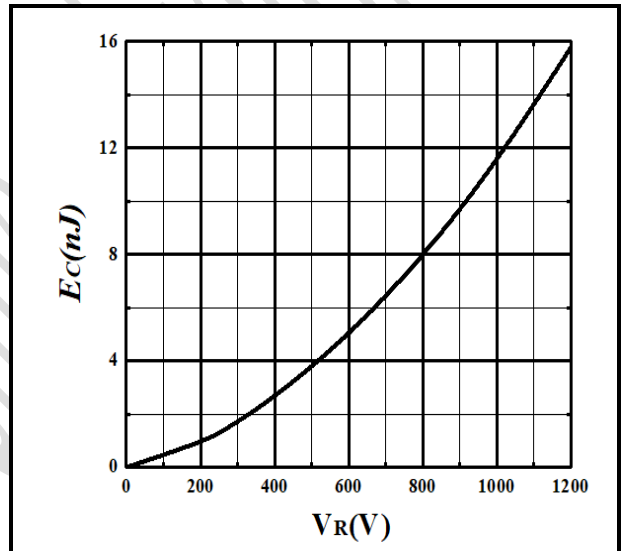

Figure 6. Capacitance Stored Energy

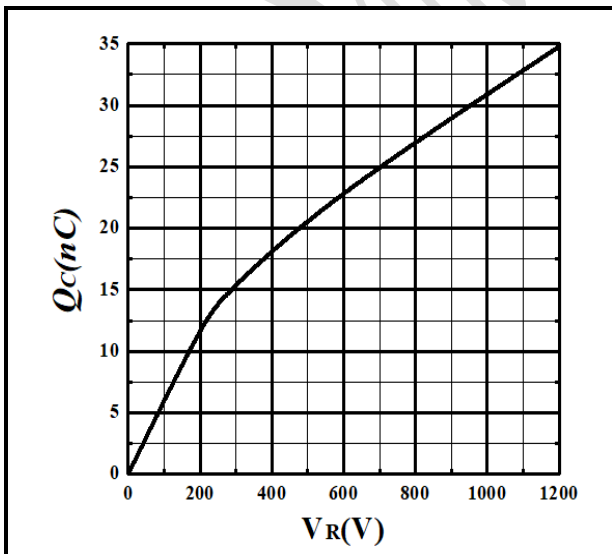
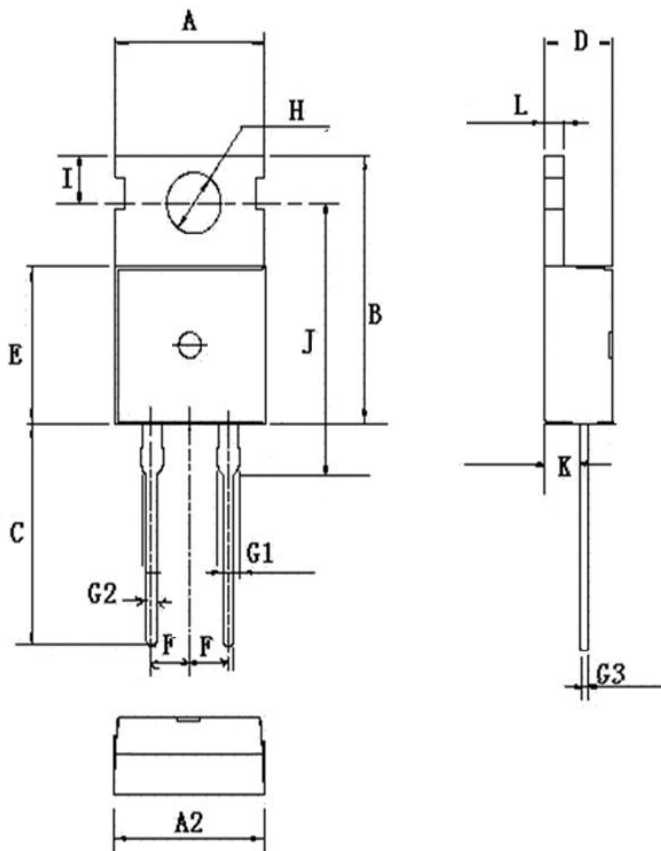

Figure 7. Total Capacitance Charge vs. Reverse Voltage

## Package



SYMBOL	mm		
	MIN	NOM	MAX
A	9.66	9.90	10.28
A2	9.80	10.00	10.20
B	15.60	15.70	15.80
C	12.70	13.08	14.27
D	4.30	4.50	4.70
E	8.59	9.20	9.40
F	2.54 BSC		
G1	1.32	1.52	1.62
G2	0.70	0.80	0.95
G3	0.45	0.50	0.60
H dia.	3.50	3.60	3.70
I	2.70	2.80	2.90
J	15.70	15.90	16.25
K	2.20	2.40	2.90
L	1.15	1.30	1.40

## Ordering information

Part Number	SDS120J005C2-ISATH
Package	TO-220-2L
Unit Quantity	1000 EA
Packing Type	Tube
RoHS	Yes