

交流瓷介电容器

AC CERAMIC CAPACITORS

□用途

该产品主要用于家用电器、办公设备、电子仪器、及其它电子产品作跨电源线、消火花、天地线耦合和旁路电容等。

□Application

Using as jumper wire, spark killer, antenna coupling, ground coupling, and bypass capacitors in household appliances, office equipment, electronic equipment and other electronic products.

□安全认证 (safe authentication)

认证名称 Certification name	认证标记 Mark	认证类别 Categories	认证电容量分类 scope	认证标准 standards	证书编号 NO.
中国 CQC CHINA CQC		AC250/400V X1 AC250V/400V Y1	2pF~4700pF	GB/T6346.14-2015	CQC02001002287
		AC250/400V X1 AC250V/300V Y2	2pF~10000pF		CQC02001002289
美国 UL USA UL		AC400V X1 AC250V/400V Y1	2pF~4700pF	UL60384-14	E145038
		AC400V X1 AC250V/300V Y2	100pF~10000pF	UL60384-14 CSA E60384-14:09	
德国 VDE Germany VDE		AC250V/400V Y1	2pF~4700pF	DIN EN60384-14 (VDE0565-1-1): 2014-04 EN60384-14:2013-08 IEC60384-14 (ed. 4)	135256
		AC250V Y2	100pF~10000pF		
		AC400V X1	100pF~10000pF		
加拿大 CSA Canada		AC400V X1 AC400V Y1	2pF~4700pF	CAN/CSA-E60384-14:09 CAN/CSA-E60384-1:03	2492570 (LR107420)
		AC400V X1 AC250V Y2	100pF~10000pF	CAN/CSA-E60384-14:09 ANSI/UL 60384-14-2009	2492571 (LR107420)
挪威 NEMKO Norway NEMKO		AC400V X1 AC250V/400V Y1	2pF~4700pF	EN60384-14: 2013	P16220678
瑞典 SEMKO Sweden SEMKO		AC400V X1 AC250V/400V Y1	2pF~4700pF	EN60384-14: 2013	1606405
芬兰 FIMKO Finland FIMKO		AC400V X1 AC250V/400V Y1	2pF~4700pF	EN60384-14: 2013	29430
丹麦 DEMKO Denmark DEMKO		AC400V X1 AC250V/400V Y1	2pF~4700pF	EN60384-14: 2013	D-04994

□ 编带 (Taping Package):

● b 式 (引线间距 $F=10.0\text{mm}$, 孔间距 $P0=12.7\text{mm}$, 产品间距 $P=25.4\text{mm}$)

Type b (lead spacing $F=10.0\text{mm}$, Hole spacing $P0=12.7\text{mm}$, Product spacing $P=25.4\text{mm}$)

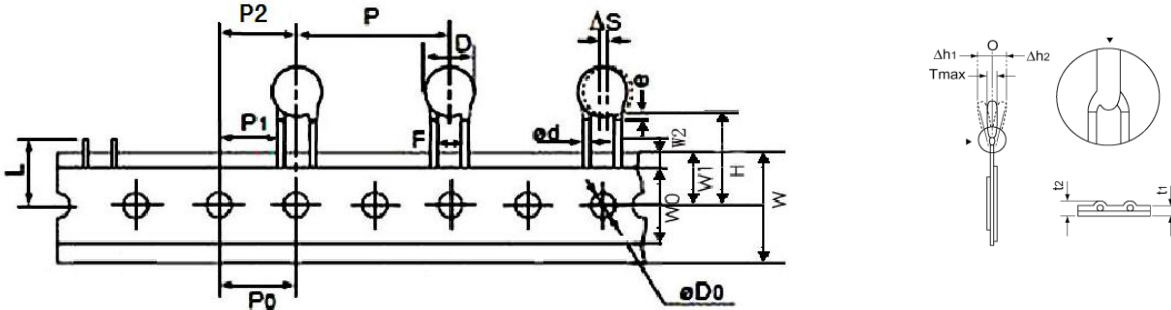

项目 Item	代号 Code	尺寸 Dimensions (mm)
引线线径 Lead diameter	d	0.56 ± 0.056
产品间距 Pitch of component	P	25.4 ± 1.0
传送孔间距 Pitch of sprocket hole	P0	12.7 ± 0.3
传送孔位置偏差 Position of sprocket hole	P1	7.7 ± 1.5
	P2	12.7 ± 1.3
引线间距 Lead spacing	F	10.0 ± 0.5
产品倾倒 Deviation across tape	Δh	$0 \pm 2.0\text{max}$
纸带宽度 Carrier tape width	W	18.0 ± 0.5
胶带宽度 Hold-down tape width	W0	6.0min
传送孔位置偏差 Position of sprocket hole	W1	9.0 ± 0.5
胶带偏差 Hold-down tape distortion	W2	1.5 ± 1.5
产品至纸带中心位置 Lead distance between reference and bottom planes	H	$20.0 +1.5/-1.0$
传送孔孔径 Diameter of sprocket hole	D0	4.0 ± 0.2
不良切断位置 Portion to cut	L	$11.0+0/-1.0$
包封料垂延 Coating extension on lead	e	3.5max
纸带厚度 thickness of tape	t1	0.6 ± 0.3
	t2	1.5max
引线弹性弯曲 Lead flexible blend	ΔS	0 ± 2.0

□结构(Structure)

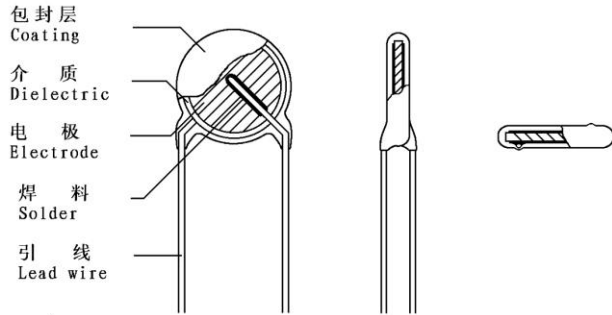

包封层(Coating) : 环氧树脂(Epoxy Resin)

介 质(Dielectric): 陶 瓷 (Ceramic)

电 极(Electrode : 银 (Silver)

焊 料(Solder) : 锡(Alloy Tin)

引 线(Lead Wire) : 镀锡引出线(Lead)

□主要材料(Main Material)

SrCO₃ BaCO₃ TiO₂ Bi₂O₃ CaCO₃ Nb₂O₅ MgO

银膏(Silver paste) 环氧树脂(Epoxy Resin)

□室内条件(Room Condition)

温度(Temp.): 15~35℃ 湿度(R. H.): 45~75%

气压(Atm pressure): 86~106kPa(860~1060mbar)

□测试条件(Test Condition)

温度(Temp.): 20±2℃ 湿度(R. H.): 50~60%

电压(Vol.): 1.0±0.2Vrms 频率(Freq.): 1±0.2KHz

□容量—温度变化曲线 Cap.—Temp. Curve

2E4

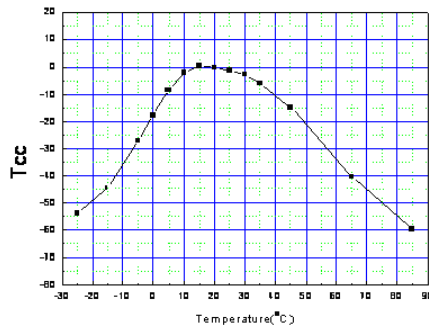

□命名方法 Part Code Designation

CT81 - 400VAC - 08 b - 2E4 - 471 M - YA - T
 ① ② ③ ④ ⑤ ⑥ ⑦ ⑧ ⑨

①种类 Class

代码 Code	种类 Class
CT81	II类高压 Class II High-Voltage

⑤温度特性 Temperature Characteristic

代码 Code	容量变化 Cap. Change
2E4	-56~+22%

②额定电压 Rated Voltage

代码 Code	额定电压 Rated Vol.	代码 Code	额定电压 Rated Vol.
400VAC	AC400V		

⑥标称容量 Rated Capacitance

代码 Code	静电容量 Capacitance	代码 Code	静电容量 Capacitance
471	470pF		

③主体外径 Body Diameter

代码 Code	D(±1.0) (mm)	代码 Code	D(±1.0) (mm)
08	6.0		

⑦容量允差 Tolerance

代码 Code	容量允差 Tolerance
M	±20%

④引线形式 Lead Shape

代码 Code	形式 Shape
b	直脚 Straight

⑧试验电压类别 Type of Test Voltage

代码 Code	试验电压 Test Voltage
YA	AC4000V

⑨包装方式 package Shape

代码 Code	形式 Shape
T	编带 Taping Package
/	散件 bulk

□ 编带包装 (Taping Package packing)

1、包装数量 (packing quantity):

引线间距 Lead spacing	包装盒分类 Kinds of plastic box	成型方式 Molding mode	包装数量 Quantity per bag	备注 Remark
F=10.0mm	1# 2#	b	500~1000	包装盒尺寸: Size of plastic box 1#: 336 × 240 × 45mm 2#: 336 × 290 × 48mm

2、包装标识 (packing marking):

示例 (Example)	项 目 (Item)	
		公司商标 (Manufacturer's Marking)
	物料编码 Code	客户要求时 When the customer require
	规格型号 Model	详见如上表格, (Please see the detail in the upper sheet)
	生产批号 Product lots	生产批号 Product lots
	生产日期 Productive date	产品生产时间 the produce time of the product
	数 量 Quantity	每盒的包装数量 the packing quantity per plastic bag

3、包装方式 (packing mode):

示例 (Example) :



步骤一 (Step1)



步骤二 (Step2)



步骤三 (Step3)

外包装箱 (over-wrap boxes) (B1:520 × 370 × 280mm、B2:358 × 312 × 275mm)

装箱数量应为最小包装的整数倍。(The packing quantity should be integral multiple of minimum packing.)。

采用瓦楞纸箱包装, 装箱不满时用空箱填充。(The corrugated box packaging, packing dissatisfaction with empty container filling)。

□规格及试验方法 Specification and Test Method

项 目 ITEM		规 格 SPECIFICATION	试 验 方 法 及 条 件 TEST METHOD AND CONDITION												
1. 存储温度范围 Storage Temp. Range		-40℃~+125℃													
2. 使用温度范围 Operating Temp. Range		-25℃~+125℃													
3. 外观尺寸 Appearance and Dimension		外观无可见损伤 尺寸在规格内 Appearance has no marked defect. Dimensions shall be within specified tolerance.	外观用目视法观测 尺寸用游标卡尺测量 Appearance be watched on sight Dimension be measured by caliper												
4. 标识 Mark		应清晰可见 Should be discerned easily.	用目视法观测 Be watched on sight												
5. 静电容量 Capacitance		在规格范围内 Within specified tolerance	温度 Temp. 20±2℃ 电压 Vol. 1.0±0.2Vrms 频率 Freq. 1±0.1KHz												
6. 损耗因数 Dissipation Factor		E:2.5% max	同上 Same condition as capacitance												
7. 绝缘电阻 Insulation Resistance		大于 10,000MΩ 10,000MΩmin	500±50V.DC 的电压充电一分钟。 The insulation Resistance shall be measured with 500±50V.DC within 60±5 sec of charging.												
8. 耐电压 Dielectric Strength	端子间 Between Lead Wires	无不良 No failure.	施加 4.0KVAC 电压 1 分钟 (充放电电流≤50mA) Apply a voltage of 4.0KVAC for 1 min. between the lead wires. (Charge/discharge current≤50mA)												
	端子与外壳间 Body Insulation	无不良 No failure.	将电容器的引线连在一起, 主体外紧包一金属箔, 边缘距引线约 3-4mm, 施加 4.0KVAC 的电压于电容器的引线和金属箔之间。 (充放电电流≤50mA) The terminals of the capacitor shall be connected together. A metal foil shall be closely wrapped around the body of the capacitor to the distance of about 3 - 4 mm from each terminal. A Voltage of 4.0KVAC is applied between the capacitor lead wires and metal foil. (Charge/discharge current <50mA)												
9. 容量温度特性 Temperature Characteristic		E:-56~+22%	<p>静电容量测试须依下列顺序进行。 预处理: 在 85±2℃ 下放置 1 小时后取出, 在室内条件下放置 24±2 小时。 The capacitance shall be measured at each step as following. Pre-treatment: Capacitor shall be stored at 85±2℃ for 1 hour, then placed at room condition for 24±2hours before initial measurements.</p> <table border="1"> <thead> <tr> <th>步骤 (Step)</th> <th>①</th> <th>②</th> <th>③</th> <th>④</th> <th>⑤</th> </tr> </thead> <tbody> <tr> <td>温度 (Temp.)</td> <td>20±2℃</td> <td>-25±2℃</td> <td>20±2℃</td> <td>85±2℃</td> <td>20±2℃</td> </tr> </tbody> </table>	步骤 (Step)	①	②	③	④	⑤	温度 (Temp.)	20±2℃	-25±2℃	20±2℃	85±2℃	20±2℃
步骤 (Step)	①	②	③	④	⑤										
温度 (Temp.)	20±2℃	-25±2℃	20±2℃	85±2℃	20±2℃										
10. 阻燃试验 Flame Test		第一至第二次循环不会产生 30 秒以上的燃烧现象, 第三次时不会产生 60 秒以上的燃烧现象。 The capacitor flame shall be discontinued not more than 30sat cycle 1 to 2 and 60 sec. At cycle 3.	将电容器放入直径 9.5mm, 高度 19mm 的火焰中烤 15 秒后取出, 在空气中停留 15 秒后再放入火焰中进行三次循环。 The capacitor should be put into the flame with diameter 9.5mm and height 19mm for 15 sec. and then removed for 15 sec. In air until 3 cycles.												

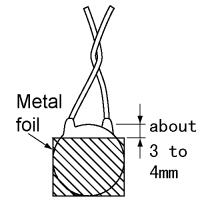

项 目 ITEM	规 格 SPECIFICATION		试 验 方 法 及 条 件 TEST METHOD AND CONDITION
11. 易焊性 Solder ability of lead wires	导线上沾锡面积大于 90%。 Lead wire shall be soldered with uniformly coated on the axial direction over 90% of the circumferential direction .		导线须浸入助焊剂后再浸入 245±5℃的熔锡内, 松香浓度 25%wt, 距离主体 2.0~2.5mm, 时间 2±0.5 秒。 The lead wires of the capacitor shall be dipped into a alcohol solution of 25% wt rosin and then into molten solder of 245±5℃ for 2±0.5 sec. In both case the depth of dipping is up to about 2.0 to 2.5 mm from the root of the lead wires.
12. 端子强度 Strength of Lead Wires (c 式不做此项 Type c none)	抗拉强度 Pull	导线不断裂 电容器不破损 Lead wire shall not cut off and capacitor shall not be damaged	把制品固定, 在端子引出方向施加负荷 10N 保持 10±1 秒。 Fix the body of the capacitor and apply a tensile weight gradually to each lead wire in the radial direction of capacitor up to 10N, and keep it for 10 ±1sec.
	弯曲强度 Bending		在端子间施加 5N 负荷并弯曲 90°, 回复原后反向弯曲 90°, 每次弯曲时间为 2 至 3 秒, 连续 2 次。 Each lead wire shall be subjected to 5N weight and then a 90° bend, at the point of egress, in one direction return to original position, and then a 90° bend in the opposite direction at the rate of one bend in 2-3 s for 2times.
13. 耐焊接热 Soldering Effect	外观 Appearance	无显著异常 No marked defect	将端子浸入温度为 260±5℃的熔锡内, 外保留 1.5~2.0mm 距离主体边缘, 并保持 5.0±0.5 秒。 试验前: 电容器应放置在 125±2℃的温度下 1 小时, 然后在常温下恢复 24±2 小时后测试。 试验后: 室内条件下恢复 24±2 小时。 The lead wires shall be immersed into the melted solder of 260±5℃ up to about 1.5 to 2.0 mm from the main body for 5.0±0.5 sec. Pre-treatment: The capacitor shall be placed at 125±2℃ for 1 hour, then placed at room condition for 24±2 hours before initial measurement. Post-treatment: Capacitor shall be stored for 24±2 hours at room condition.
	容量变化 Capacitance Change	E: ±20% max	
	抗电强度 Dielectric Strength	按第八条。 Per Item 8.	
14. 耐振性 Vibration Resistance	外观 Appearance	无显著异常 No marked defect	电容器须焊锡固定好, 固定点距电容器主体 3±1.0mm, 并经 10Hz→500Hz 之振动频率, 全振幅 1.5mm, 振动时间为 6 小时, 往 X、Y、Z 轴三个方向(各 2 小时)。 试验前: 电容器应放置在 125±2℃的温度下 1 小时, 然后在常温下恢复 24±2 小时 后测试。 试验后: 在室内条件下恢复 24±2 小时测试。 The capacitor shall firmly be soldered to the supporting lead wires about 3±1.0 mm from the body of the capacitor and vibration which is 10 to 500Hz in the vibration frequency range, 1.5mm in total amplitude, for a total of 6 hours, 2 hours each in three mutually perpendicular directions. pre-treatment: The capacitor shall be placed at 125±2℃ for 1 hour, then placed at room condition for 24±2 hours before initial measurement. Post-treatment: Capacitor shall be stored for 24±2 hours at room conditions.
	容量变化 Capacitance Change	E: ±15% max	
15. 湿热循环 Humidity Cycling	外观 Appearance	无显著异常 No marked defect	电容器在温度 40±2℃, 湿度 95±3%RH 下放置 8 小时, 室温下放置 16 小时, 循环 5 次。 试验后: 在室内条件下恢复 1 至 2 小时。 Set the capacitor for 8 hours at 40±2℃ in 95±3% RH, then placed at room condition for 16 hours, circulating for 5 times. Post-treatment: The capacitor shall be stored for 1 to 2 hours at room condition.
	容量变化 Capacitance Change	E: ±20% max	
	损耗因数 D.F.	E: 5.0% max	
	绝缘电阻 I.R.	1500MΩ min	
	抗电强度 Dielectric Strength	按第八条。 Per Item 8.	

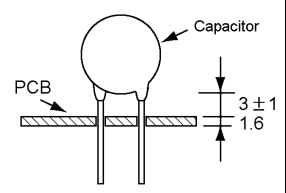
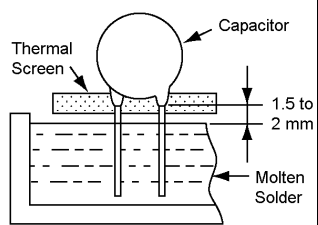
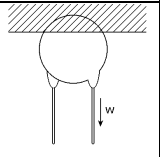

项 目 ITEM	规 格 SPECIFICATION		试 验 方 法 及 条 件 TEST METHOD AND CONDITION				
16. 碰撞试验 Collision Resistance	外观 Appearance	无显著异常 No marked defect	电容器须焊锡固定好,固定点距电容器主体 3 ± 1.0 mm,并施加一加速度为 390m/s^2 ,脉冲时间为 6ms 的碰撞,次数为 4000 次。 试验前: 电容器应放置在 $125 \pm 2^\circ\text{C}$ 的温度下 1 小时,然后在常温下恢复 24 ± 2 小时后测试。 试验后: 在室内条件下恢复 24 ± 2 小时测试。 The capacitor shall firmly be soldered to the supporting lead wire about 3 ± 1.0 mm from the body of the capacitor and a collision which is 390m/s^2 in the acceleration, 6ms in the pulse cycle for 4000 times. pre-treatment: The capacitor shall be placed at $125 \pm 2^\circ\text{C}$ for 1 hour, then placed at room condition for 24 ± 2 hours before initial measurement. Post-treatment: Capacitor shall be stored for 24 ± 2 hours at room conditions				
	容量变化 Capacitance Change	E: $\pm 15\%$ max					
	损耗因数 D.F.	E: 2.5% max					
17. 温度循环 Temp Cycling	外观 Appearance	无显著异常 No marked defect	将电容器放入高低温箱,按下列步骤循环 5 次。 试验前: 在 $125 \pm 2^\circ\text{C}$ 温度下放置 1 小时,在常温下恢复 24 ± 2 小时后测试。 试验后: 在室内条件下恢复 24 ± 2 小时测试。 The capacitor shall be introduced into the test chamber, and shall be exposed to the temperature conditions as shown in table at 5 cycles. pretreatment: The capacitor shall be placed at $125 \pm 2^\circ\text{C}$ for 1 hour, then placed at room condition for 24 ± 2 hours before initial measurement. Post-treatment: Capacitor shall be stored for 24 ± 2 hours at room conditions.				
	容量变化 Capacitance Change	E: $\pm 20\%$ max					
	损耗因数 D.F.	E: 5.0% max					
	绝缘电阻 I.R.	$1000\text{M}\Omega$ min					
			步骤 (STEP)	1	2	3	4
			温度 (TEMP.)	$-25 \pm 3^\circ\text{C}$	$20 \pm 2^\circ\text{C}$	$125 \pm 3^\circ\text{C}$	$20 \pm 2^\circ\text{C}$
			时间 (TIME)	$30 \pm 3\text{min.}$	3min. max	$30 \pm 3\text{min.}$	3min. max
18. 耐湿性 Humidity (Under Steady State)	外观 Appearance	无显著异常 No marked defect	电容器在温度 $40 \pm 2^\circ\text{C}$,湿度 $95 \pm 3\% \text{RH}$ 下放置 500 ± 12 小时。 试验前: 电容器应放置在 $125 \pm 2^\circ\text{C}$ 的温度下 1 小时,然后在常温下恢复 24 ± 2 小时后测试。 试验后: 在室内条件下恢复 24 ± 2 小时。 Set the capacitor for 500 ± 12 hours at $40 \pm 2^\circ\text{C}$ in $95 \pm 3\% \text{RH}$. pre-treatment: The capacitor shall be placed at $125 \pm 2^\circ\text{C}$ for 1 hour, then placed at room condition for 24 ± 2 hours before initial measurement. Post-treatment: The capacitor shall be stored for 24 ± 2 hours at room condition.				
	容量变化 Capacitance Change	E: $\pm 20\%$ max					
	损耗因数 D.F.	E: 5.0% max					
	绝缘电阻 I.R.	$1500\text{M}\Omega$ min					
	抗电强度 Dielectric Strength	按第八条。 Per Item 8					
19. 寿命试验 Life Test	外观 Appearance	无显著异常 No marked defect	在 $125 \pm 2^\circ\text{C}$ 下放置 1000 ± 48 小时,并施加 500VAC,每小时升高到 1000V.AC 持续 0.1 秒。 试验前: 在 $125 \pm 2^\circ\text{C}$ 放置 1 小时,在室内条件下恢复 24 ± 2 小时。 试验后: 在室内条件下恢复 24 ± 2 小时。 Apply a voltage of 500V.AC, except that once each hour the voltage is increased to 1000V.AC for 0.1sec. that shall be maintained for 1000 ± 48 hours at $125 \pm 2^\circ\text{C}$. Pre-treatment: Capacitor shall be stored at $125 \pm 2^\circ\text{C}$ for 1 hour, then placed at room condition for $24 \pm 2\text{H}$ before initial measurements. Post-treatment: Capacitor shall be stored for 24 ± 2 hours at room condition.				
	容量变化 Capacitance Change	E: $\pm 20\%$ max					
	损耗因数 D.F.	E: 5.0% max					
	绝缘电阻 I.R.	$1500\text{M}\Omega$ min					
20. 放电试验 Discharge Test	外观 Appearance	无显著异常 No marked defect	如图,由 Cd 经 Vs 充电后向被测电容 Ct 放电,充放电时间均为 5 秒,一共 50 次。 As in figure, discharge is made 50 times at 5 sec. intervals from the capacitor (Cd) charged at DC voltage of specified. Ct: 被测电容 Capacitor under test S: 高压开关 High-voltage switch R1: 1000Ω R2: $4\text{M}\Omega$ R3: 浪涌电阻 Surge resistance Cd: 1nF Vs: 10KVDC				
	绝缘电阻 I.R.	大于 $1000\text{M}\Omega$ $1000\text{M}\Omega$ min					
	抗电强度 Dielectric Strength	按第八条。 Per Item 8					

