

交流瓷介電容器

AC CERAMIC CAPACITORS

用途

該產品主要用於家用電器、辦公設備、電子儀器、及其它電子產品作跨電源線、消火花、天地線耦合和旁路電容等。

Application

Using as jumper wire、spark killer、antenna coupling、ground coupling、and bypass capacitors in household appliances、office equipment、electronic equipment and other electronic products.

安全認證 (safe authentication)

認證名稱 Certification name	認證標記 Mark	認證類別 Categories	認證電容量分類 scope	認證標準 standards	證書編號 NO.
中國 CQC CHINA CQC		AC250/400V X1 AC250V/400V Y1	2pF~4700pF	GB/T6346.14-2015	CQC02001002287
		AC250/400V X1 AC250V/300V Y2	2pF~10000pF		CQC02001002289
美國 UL USA UL		AC400V X1 AC250V/400V Y1	2pF~4700pF	UL60384-14	E145038
		AC400V X1 AC250V/300V Y2	100pF~10000pF	UL60384-14 CSA E60384-14:09	
德國 VDE Germany VDE		AC250V/400V Y1	2pF~4700pF	DIN EN60384-14 (VDE0565-1-1): 2014-04 EN60384-14:2013-08 IEC60384-14 (ed. 4)	135256
		AC250V Y2	100pF~10000pF		
		AC400V X1	100pF~10000pF		
加拿大 CSA Canada		AC400V X1 AC400V Y1	2pF~4700pF	CAN/CSA-E60384-14:09 CAN/CSA-E60384-1:03	2492570 (LR107420)
		AC400V X1 AC250V Y2	100pF~10000pF	CAN/CSA-E60384-14:09 ANSI/UL 60384-14-2009	2492571 (LR107420)
韓國 KTL Korea KTL		AC250V Y1	2pF~4700pF	KC60384-1 (2014-09) KC60384-14 (2014-09)	SU03029-7001D
		AC400V X1	100pF~10000pF	K60384-14 (2006-12)	SU03029-7002C
		AC250V Y2	100pF~10000pF	K60384-14 (2006-12)	SU03029-7003C
挪威 NEMKO Norway NEMKO		AC400V X1 AC250V/400V Y1	2pF~4700pF	EN60384-14 : 2013	P16220678
瑞典 SEMKO Sweden SEMKO		AC400V X1 AC250V/400V Y1	2pF~4700pF	EN60384-14 : 2013	1606405
芬蘭 FIMKO Finland FIMKO		AC400V X1 AC250V/400V Y1	2pF~4700pF	EN60384-14 : 2013	29430
丹麥 DEMKO Denmark DEMKO		AC400V X1 AC250V/400V Y1	2pF~4700pF	EN60384-14 : 2013	D-04994

規格型號 (Specification type)

編碼 CODE	品名 CODE NO.	成品尺寸 Product Dimensions				內芯尺寸 The inner core Dimensions		單片重 Single weight
		D±1.0 (mm)	T±1.0 (mm)	F±1.0 (mm)	d±0.056 (mm)	D'±0.3 (mm)	T'±0.3 (mm)	
J90105-9106I-RF	CT81-400VAC-07b-B68K-1YA-3T3	6.5	4.5	10.0	0.56	4.8	1.9	0.489
J90105-8740I-RF	CT81-400VAC-07b-B82K-1YA-3T3	6.0	3.8max	10.0	0.56	4.8	1.8	0.388
J90105-9328I-RF	CT81-400VAC-08b-B151K-1YA-3T3	6.5	4.5	10.0	0.56	4.8	1.9	0.398
J90105-9568I-RF	CT81-400VAC-10b-B681K-1YA-3T3	9.0	4.5	10.0	0.56	8.0	1.7	0.870
X90105-8785I-RF	CT81-400VAC-11b-E222M-1YA-3T3	9.0	4.5	10.0	0.56	8.0	1.9	0.946
X90105-8771I-RF	CT81-400VAC-11e-E222M-1YA-3T3	9.0	4.5	10.0	0.56	8.0	1.9	0.954
X90105-8784I-RF	CT81-400VAC-08b-E102M-1YA-3T3	6.5	4.5	10.0	0.56	5.5	1.9	0.629
	CT81-400VAC-08b-B101K-2YA-3T3	6.5	5.0	10.0	0.56	5.1	2.1	0.626
X90105-8780I-RF	CT81-400VAC-08b-B221K-2YA-3T3	6.0	4.5	10.0	0.56	4.8	2.1	0.543
X90105-8761I-RF	CT81-400VAC-08b-B271K-2YA-3T3	6.5	4.5	10.0	0.56	5.5	2.1	0.564
X90105-8781I-RF	CT81-400VAC-08b-B331K-2YA-3T3	7.0	4.5	10.0	0.56	5.9	2.1	0.670
X90105-8782I-RF	CT81-400VAC-09b-B471K-2YA-3T3	8.5	4.5	10.0	0.56	7.2	2.1	0.855
	CT81-400VAC-11b-B681K-2YA-3T3	10.0	4.5	10.0	0.56	8.7	2.1	1.172
	CT81-400VAC-08b-E102M-2YA-3T3	7.0	4.5	10.0	0.56	5.9	2.1	0.663
X90105-8766I-RF	CT81-400VAC-08b-B221K-3YA-3T3	6.5	4.5	10.0	0.56	5.1	2.2	0.601
X90105-8746I-RF	CT81-400VAC-09b-B471K-3YA-3T3	8.5	4.0	10.0	0.56	7.2	2.1	0.893
X90105-8745I-RF	CT81-400VAC-09e-B471K-3YA-3T3	8.5	4.0	10.0	0.56	7.2	2.1	0.824
X90105-9726I-RD	CT81-250VAC-08b-B471K-2YB-2T3	7.0	3.5	7.5	0.56	5.9	1.5	0.541

成品及內芯尺寸圖 Product And The Inner Core Dimensions :

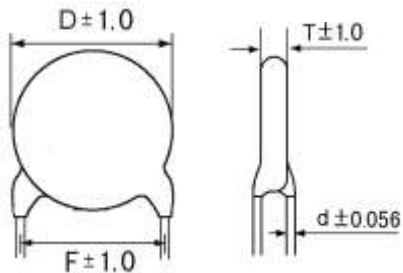

成品尺寸 (Product Dimensions)

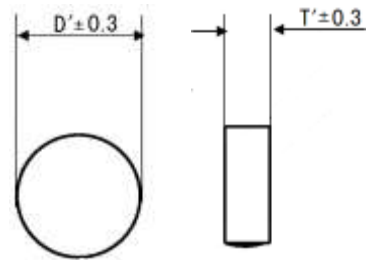

內芯尺寸 (The inner core Dimensions)

□標記 (Marking)

示例 (Example)		項目 (Item)	
1YB		CT81	種類 (Class)
		221/471	標稱容量 (Rated Capacitance)
		K	容量誤差 (Tolerance of Capacitance)
1YA		.LY	LY:公司代號; “.” 的位置不同代表不同的生產線產品; 無點代表 3YA 產品。 .LY:一號產線 .LY:二號產線 (LY:Manufacturer's Code ; “.” the location of the different representative production line ;No point represents 3YA product. .LY:No.1 production line .LY:No.2 production line)
2YA			
3YA			CSA 認證標記 (CSA Monogram)
			VDE 認證標記 (VDE Approval Mark)
			CQC 認證標記 (CQC Approval Mark)
		L	Surge
		3B5	生產日期 Production Date

說明：生產日期第一位表示製作年度，標示方法參照年度對照表；第二位表示製作月份，第三位表示具體製作日期，標示方法參照 34 進制對比表；例如：生產日期 3B5 表示：3:13 年 B:11 月，5:5 日

(Production date first said the annual, marking methods according to annual comparison table; second said production month, third said the specific production date marking method of comparison, table 34 hexadecimal; Example : Production date 3B5 show: 3:2013year B: november 5: the 5 day) :

年度對比表：

年 度	2013	2014	2015	2016	2017	2018	2019
年代碼	3	4	5	6	7	8	9
年 度	2020	2021	2022	2023	2024	以此類推	
年代碼	0	1	2	3	4		

34 進制對比表：

34 進制	0	1	2	3	4	5	6	7	8	9	A	B	C	D	E	F	H
10 進制	0	1	2	3	4	5	6	7	8	9	10	11	12	13	14	15	16
34 進制	J	K	L	M	N	P	Q	R	S	T	V	W	X	Y	Z		
10 進制	17	18	19	20	21	22	23	24	25	26	27	28	29	30	31		

□引線形式 Lead Shape

編帶(Taping Package):

- b 式 (引線間距 $F=10.0\text{mm}$ 產品間距 $P=P_0=15.0\text{mm}$)

Type b (lead spacing $F=10.0\text{mm}$ Product spacing $P=P_0=15.0\text{mm}$)

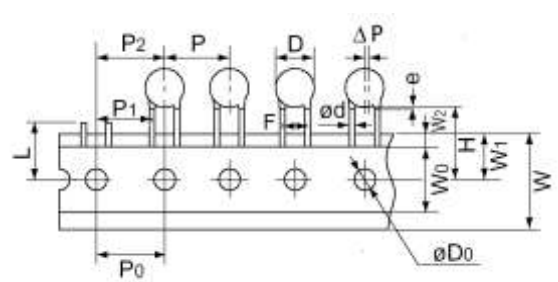
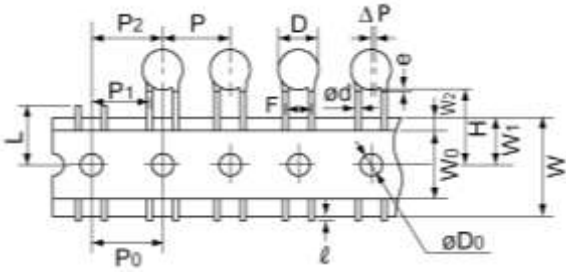

- b 式 (引線間距 $F=7.5\text{mm}$ 產品間距 $P=P_0=15.0\text{mm}$)

Type b (lead spacing $F=7.5\text{mm}$ Product spacing $P=P_0=15.0\text{mm}$)

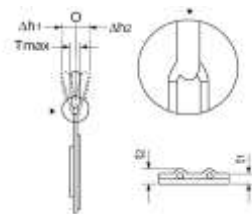
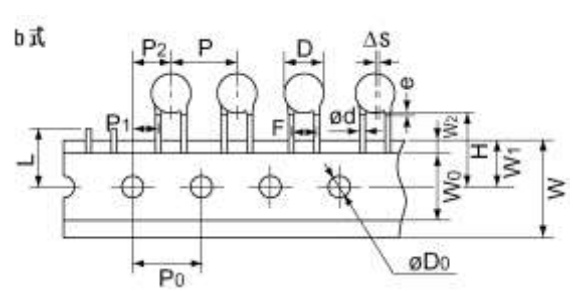
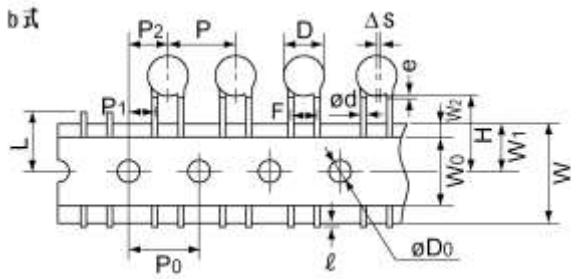

注：左侧编带图为一次编带，右侧编带图为二次编带 (left banding diagram is primary banding ;right banding diagram is secondary banding.)

項目 Item	代號 Code	尺寸 Dimensions (mm)	
		b式 Type b	
引線間距 Lead spacing	F	7.5±1.0	10.0±1.0
產品間距 Pitch of component	P	15.0±1.0	15.0±1.0
傳送孔間距 Pitch of sprocket hole	P0	15.0±0.3	15.0±0.3
傳送孔位置偏差 Position of sprocket hole	P1	3.75±0.7	10.0±1.5
	P2	7.5±1.3	15.0±1.3
引線線徑 Lead diameter	d	0.56±0.056	
產品傾倒 Deviation across tape	Δh	0±2.0max	
紙帶寬度 Carrier tape width	W	18.0±0.5	
膠帶寬度 Hold-down tape width	W0	6.0min	
傳送孔位置偏差 Position of sprocket hole	W1	9.0±0.5	
膠帶偏差 Hold-down tape distortion	W2	1.5±1.5	
產品至紙帶中心位置 Lead distance between reference and bottom planes	H	20.0 +1.5/-1.0	
傳送孔孔徑 Diameter of sprocket hole	D0	4.0±0.2	
不良切斷位置 Portion to cut	L	11.0+0/-1.0	
包封料垂延 Coating extension on lead	e	3.0max	
紙帶厚度 thickness of tape	t1	0.6±0.3	
	t2	1.5max	
引線彈性彎曲 Lead flexible blend	ΔP	0±2.0	
產品片徑 Product diameter	D	見第 6 頁：規格型號 See page 6:Specification Type	
產品厚度 Product thickness	T	見第 6 頁：規格型號 See page 6:Specification Type	
引線尾端長度 Lead the end of length	ℓ	1.0max	

結構(Structure)

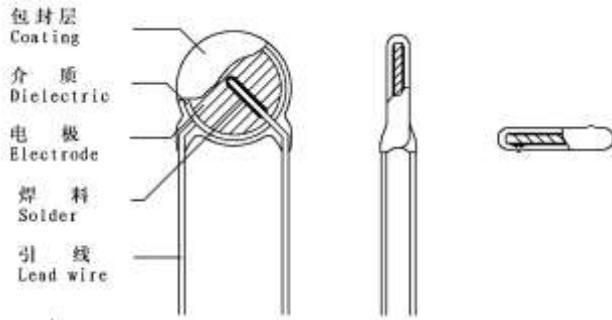

包封層(Coating) : 環氧樹脂(Epoxy Resin)

介質(Dielectric): 陶瓷 (Ceramic)

電極(Electrode : 銀 (Silver)

焊料(Solder) : 錫(Alloy Tin)

引線(Lead Wire) : 鍍錫引出線(Lead)

主要材料(Main Material)

序號 NO.	材料名稱(Material name)	規格(Specifications)
1	介質 Ceramic core	CT81 AC
2	電極 Silver paste	SP-255PL SP-YD55
3	包封料 Expoxy powder coating	HXF-240 XCP-231 EF-150
4	鍍錫線 Tin-plated copper weld Steel wire	0.56
5	無鉛焊料 Unleaded solder	97%Sn 2.5%Ag 0.5%Cu

室內條件(Room Condition)

溫度(Temp.) : 15~35℃ 濕度(R. H.) : 45~75%
氣壓(Atm pressure) : 86~106kPa(860~1060mbar)

測試條件(Test Condition)

溫度(Temp.) : 20±2℃ 濕度(R. H.) : 50~60%
電壓(Vol.) : 1.0±0.2Vrms 頻率(Freq.) : 1±0.2KHz

容量—溫度變化曲線 Cap.—Temp. Curve

B(Y5P)

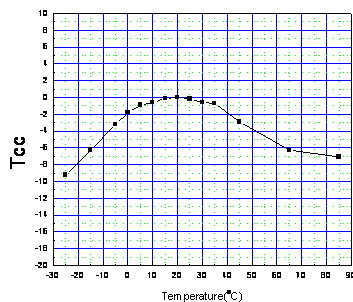

E(Y5U)

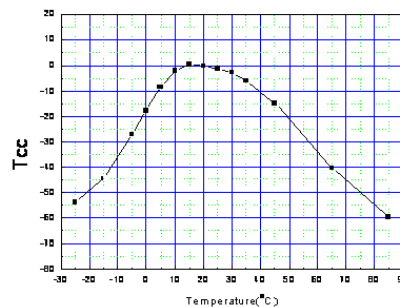

□命名方法 Part Code Designation

CT81 - 400VAC - 08 b - B 221 K - 2YA - 3 T3

① ② ③ ④ ⑤ ⑥ ⑦ ⑧ ⑨ ⑩

①種類 Class

代碼 Code	種類 Class
CT81	Ⅱ類高壓 Class II High-Voltage

⑥標稱容量 Rated Capacitance

代碼 Code	靜電容量 Capacitance	代碼 Code	靜電容量 Capacitance
221	220pF	471	470pF
331	330pF	102	1000pF
以此类推 And So on			

②額定電壓 Rated Voltage

代碼 Code	額定電壓 Rated Vol.	代碼 Code	額定電壓 Rated Vol.
400VAC	AC400V		
250VAC	AC250V		

⑦容量允差 Tolerance

代碼 Code	容量允差 Tolerance
K	±10%
M	±20%

③主體外徑 Body Diameter

代碼 Code	Dmax (mm)	代碼 Code	Dmax (mm)
07	7.5	10	10.0
08	8.5	11	11.0
09	9.5		

⑧試驗電壓類別 Type of Test Voltage

代碼 Code	試驗電壓 Test Voltage
1YA	Ordinary Products X1 Y1: AC4000V
2YA	Surge X1 Y1: 6.3KVDC; 4.0KVAC
3YA	Surge X1 Y1: 6.3KVDC; 4.0KVAC; low leakage
1YB	Ordinary Products X1 Y2: AC2600V
2YB	Surge X1 Y2: 4.5KVDC; 2.6KVAC
注: X1: 4.3U _{DC} ; Y1: 4.0KVAC	

④引線形式 Lead Shape

代碼 Code	形式 Shape
b	直腳 Straight long

⑨引線間距 Lead spacing

代碼 Code	間距 spacing
1	5.0mm
2	7.5mm
3	10.0mm

⑤溫度特性 Temperature Characteristic

代碼 Code	容量變化 Cap. Change
B(Y5P)	-10~+10%
E(Y5U)	-56~+22%

⑩包裝方式 package Shape

代碼 Code	散件長度 Bulk Length	代碼 Code	編帶形式 Taping Package Shape
L	20.0mm min	T1	P0=12.7 P=12.7 mm
h	4.0±1.0mm	T2	P0=12.7 P=25.4 mm
X	按客戶要求 customer requirements	T3	P0=15.0 P=15.0 mm
		T4	P0=15.0 P=30.0 mm

□包裝 (packing)

編帶包裝 (Taping Package packing)

1、包裝數量 (packing quantity):

引線間距 Lead spacing	包裝盒分類 Kinds of plastic box	成型方式 Molding mode	包裝數量 Quantity per bag	箱裝數量 Quantity per box (pcs)
F=10.0mm P=P0=15.0mm	1#	b	1000~2000	10000/20000
F=7.5mm P=P0=15.0mm	1#	b	1000~2000	10000/20000
包裝盒尺寸 Size of plastic box: 1#: 336x245x46mm 外包装箱 Size of over-wrap boxes: 520x370x280mm				

2、包裝標識 (packing marking):

示例(Example)	項目(Item)	
		公司商標 (Manufacturer's Marking)
		環保標識 RoHS Designation
	物料編碼 Code	用戶要求時 When the customer require
	規格型號 Model	詳見如上表格, (Please see the detail in the upper sheet)
	生產批號 Product lots	生產批號 Product lots
	成型代號 lead shape	用戶要求時 When the customer require
	生產日期 Productive date	產品生產時間 the produce time of the product
	數量 Quantity	每盒的包裝數量 the packing quantity per plastic bag

3、外包装 (over-wrap packing):



步驟一(Step1)



步驟二(Step2)



步驟三(Step3)

裝箱數量應為最小包裝的整數倍。(The packing quantity should be integral multiple of minimal packaging.)

採用瓦楞紙箱包裝, 每箱裝 10 盒編帶產品, 裝箱不滿時用空箱填充。(The corrugated box packaging, Each box 10 boxes of Taping products, packing dissatisfaction with empty container filling)。

□規格及試驗方法 Specification and Test Method

項目 ITEM		規格 SPECIFICATION	試驗方法及條件 TEST METHOD AND CONDITION												
1. 存儲溫度範圍 Storage Temp. Range		-40°C~+125°C													
2. 使用溫度範圍 Operating Temp. Range		-25°C~+125°C													
3. 外觀尺寸 Appearance and Dimension		外觀無可見損傷 尺寸在規格內 Appearance has no marked defect. Dimensions shall be within specified tolerance.	外觀用目視法觀測 尺寸用遊標卡尺測量 Appearance be watched on sight Dimension be measured by caliper												
4. 標識 Mark		應清晰可見 Should be discerned easily.	用目視法觀測 Be watched on sight												
5. 靜電容量 Capacitance		在規格範圍內 Within specified tolerance	溫度 Temp. 20±2°C 電壓 Vol. 1.0±0.2Vrms 頻率 Freq. 1±0.1KHz												
6. 損耗因數 Dissipation Factor		B, E: 2.5% max	同上 Same condition as capacitance												
7. 絕緣電阻 Insulation Resistance		大於 10,000MΩ 10,000MΩmin	500±50V. DC 的電壓充電一分鐘. The insulation Resistance shall be measured with 500±50V. DC within 60±5 sec of charging.												
8. 耐電壓 Dielectric Strength	端子間 Between Lead Wires	無不良 No failure.	施加 4.0KVAC 電壓 1 分鐘 (充放電電流≤50mA) (YB:2.6KVAC) Apply a voltage of 4.0KVAC for 1 min. between the lead wires. (Charge/discharge current≤50mA) (YB:2.6KVAC)												
	端子與外殼間 Body Insulation	無不良 No failure.	將電容器的引線連在一起, 主體外緊包一金屬箔, 邊緣距引線約 3-4mm, 施加 4.0KVAC 的電壓於電容器的引線和金屬箔之間. (充放電電流≤50mA) (YB:2.6KVAC) The terminals of the capacitor shall be connected together. A metal foil shall be closely wrapped around the body of the capacitor to the distance of about 3 - 4 mm from each terminal. A Voltage of 4.0KVAC is applied between the capacitor lead wires and metal foil. (YB:2.6KVAC) (Charge/discharge current <50mA)												
9. 容量溫度特性 Temperature Characteristic		B: -10~+10% E: -56~+22%	靜電容量測試須依下列順序進行. 預處理: 在 85±2°C 下放置 1 小時後取出, 然後在室內條件下放置 24±2 小時後測試. The capacitance shall be measured at each step as following. Pre-treatment: Capacitor shall be stored at 85±2°C for 1 hour, then placed at room condition for 24±2hours before measurements.												
			<table border="1"> <thead> <tr> <th>步驟(Step)</th> <th>①</th> <th>②</th> <th>③</th> <th>④</th> <th>⑤</th> </tr> </thead> <tbody> <tr> <td>溫度(Temp.)</td> <td>20±2°C</td> <td>-25±2°C</td> <td>20±2°C</td> <td>85±2°C</td> <td>20±2°C</td> </tr> </tbody> </table>	步驟(Step)	①	②	③	④	⑤	溫度(Temp.)	20±2°C	-25±2°C	20±2°C	85±2°C	20±2°C
步驟(Step)	①	②	③	④	⑤										
溫度(Temp.)	20±2°C	-25±2°C	20±2°C	85±2°C	20±2°C										
10. 阻燃試驗 Flame Test		第一至第二次迴圈不會產生 30 秒以上的燃燒現象, 第三次時不會產生 60 秒以上的燃燒現象。 The capacitor flame shall be discontinued not more than 30sat cycle 1 to 2 and 60 sec. At cycle 3.	將電容器放入直徑 9.5mm, 高度 19mm 的火焰中烤 15 秒後取出, 在空氣中停留 15 秒後再放入火焰中進行三次迴圈。 The capacitor should be put into the flame with diameter 9.5mm and height 19mm for 15 sec. and then removed for 15 sec. In air until 3 cycles.												

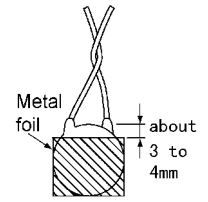

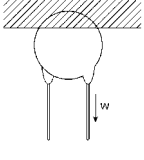
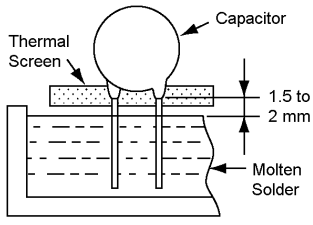
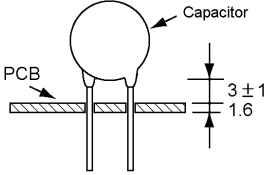
項目 ITEM	規格 SPECIFICATION		試驗方法及條件 TEST METHOD AND CONDITION
11. 易焊性 Solderability of lead wires	導線上沾錫面積大於 90%。 Lead wire shall be soldered with uniformly coated on the axial direction over 90% of the circumferential direction .		導線須浸入助焊劑後再浸入 245±5℃的熔錫內, 松香濃度 25%wt, 距離主體 2.0~2.5mm, 時間 2±0.5 秒。 The lead wires of the capacitor shall be dipped into a alcohol solution of 25% wt rosin and then into molten solder of 245±5℃ for 2±0.5 sec. In both case the depth of dipping is up to about 2.0 to 2.5 mm from the root of the lead wires.
12. 端子強度 Strength of Lead Wires (c 式不做此項 Type c none)	抗拉強度 Pull	導線不斷裂 電容器不破損 Lead wire shall not cut off and capacitor shall not be damaged	把製品固定, 在端子引出方向施加負荷 10N 保持 10±1 秒。 Fix the body of the capacitor and apply a tensile weight gradually to each lead wire in the radial direction of capacitor up to 10N, and keep it for 10±1sec. 
	彎曲強度 Bending		在端子間施加 5N 負荷並彎曲 90°, 回復原後反向彎曲 90°, 每次彎曲時間為 2 至 3 秒, 連續 2 次。 Each lead wire shall be subjected to 5N weight and then a 90° bend, at the point of egress, in one direction return to original position, and then a 90° bend in the opposite direction at the rate of one bend in 2-3 s for 2times.
13. 耐焊接熱 Soldering Effect	外觀 Appearance	無顯著異常 No marked defect	將端子浸入溫度為 260±5℃的熔錫內, 外保留 1.5-2.0mm 距離主體邊緣, 並保持 5.0±0.5 秒。 試驗前: 電容器應放置在 125±2℃的溫度下 1 小時, 然後在常溫下恢復 24±2 小時後測試。 試驗後: 室內條件下恢復 24±2 小時測試。 The lead wires shall be immersed into the melted solder of 260±5℃ up to about 1.5 to 2.0 mm from the main body for 5.0±0.5 sec. Pre-treatment: The capacitor shall be placed at 125±2℃ for 1 hour, then placed at room condition for 24±2 hours before measurement. Post-treatment: Capacitor shall be stored for 24±2 hours at room condition before measurement. 
	容量變化 Capacitance Change	B: ±10% max E: ±20% max	
	抗電強度 Dielectric Strength	按第八條。 Per Item 8.	
14. 耐振性 Vibration Resistance	外觀 Appearance	無顯著異常 No marked defect	電容器須焊錫固定好, 固定點距電容器主體 3±1.0mm, 並經 10Hz→500Hz 之振動頻率, 全振幅 1.5mm, 振動時間為 6 小時, 往 X·Y·Z 軸三個方向(各 2 小時)。 試驗前: 電容器應放置在 125±2℃的溫度下 1 小時, 然後在常溫下恢復 24±2 小時後測試。 試驗後: 在室內條件下恢復 24±2 小時測試。 The capacitor shall firmly be soldered to the supporting lead wires about 3±1.0 mm from the body of the capacitor and vibration which is 10 to 500Hz in the vibration frequency range, 1.5mm in total amplitude, for a total of 6hours, 2 hours each in three mutually perpendicular directions. pre-treatment: The capacitor shall be placed at 125±2℃ for 1 hour, then placed at room condition for 24±2hours before measurement. Post-treatment: Capacitor shall be stored for 24±2 hours at room conditions before measurement. 
	容量變化 Capacitance Change	B: ±10% max E: ±15% max	
15. 濕熱迴圈 Humidity Cycling	外觀 Appearance	無顯著異常 No marked defect	電容器在溫度 40±2℃, 濕度 95±3%RH 下放置 8 小時, 室溫下放置 16 小時, 迴圈 5 次。 試驗後: 在室內條件下恢復 1 至 2 小時後測試。 Set the capacitor for 8 hours at 40±2℃ in 95±3% RH, then placed at room condition for 16 hours, circulating for 5 times. Post-treatment: The capacitor shall be stored for 1 to 2 hours at room condition before measurement.
	容量變化 Capacitance Change	B: ±10% max E: ±20% max	
	損耗因數 D.F.	B, E: 5.0% max	
	絕緣電阻 I.R.	1500MΩ min	
	抗電強度 Dielectric Strength	按第八條。 Per Item 8.	

項目 ITEM	規格 SPECIFICATION		試驗方法及條件 TEST METHOD AND CONDITION				
16. 碰撞試驗 Collision Resistance	外觀 Appearance	無顯著異常 No marked defect	電容器須焊錫固定好, 固定點距電容器主體 $3\pm 1.0\text{mm}$, 並施加一加速度為 390m/s^2 , 脈衝時間為 6ms 的碰撞, 次數為 4000 次。 試驗前: 電容器應放置在 $125\pm 2^\circ\text{C}$ 的溫度下 1 小時, 然後在常溫下恢復 24 ± 2 小時後測試。 試驗後: 在室內條件下恢復 24 ± 2 小時測試。 The capacitor shall firmly be soldered to the supporting lead wire about $3\pm 1.0\text{mm}$ from the body of the capacitor and a collision which is 390m/s^2 in the acceleration, 6ms in the pulse cycle for 4000 times. pre-treatment: The capacitor shall be placed at $125\pm 2^\circ\text{C}$ for 1 hour, then placed at room condition for 24 ± 2 hours before measurement. Post-treatment: Capacitor shall be stored for 24 ± 2 hours at room conditions before measurement.				
	容量變化 Capacitance Change	B: $\pm 10\%$ max E: $\pm 15\%$ max					
	損耗因數 D.F.	B, E: 2.5% max					
17. 溫度迴圈 Temp Cycling	外觀 Appearance	無顯著異常 No marked defect	將電容器放入高低溫箱, 按下列步驟迴圈 5 次。 試驗前: 在 $125\pm 2^\circ\text{C}$ 溫度下放置 1 小時, 在常溫下恢復 24 ± 2 小時後測試。 試驗後: 在室內條件下恢復 24 ± 2 小時測試。 The capacitor shall be introduced into the test chamber, and shall be exposed to the temperature conditions as shown in table at 5 cycles. pretreatment: The capacitor shall be placed at $125\pm 2^\circ\text{C}$ for 1 hour, then placed at room condition for 24 ± 2 hours before measurement. Post-treatment: Capacitor shall be stored for 24 ± 2 hours at room conditions before measurement.				
	容量變化 Capacitance Change	B: $\pm 10\%$ max E: $\pm 20\%$ max					
	損耗因數 D.F.	B, E: 5.0% Max					
	絕緣電阻 I.R.	$1000\text{M}\Omega$ min					
			步驟 (STEP)	1	2	3	4
			溫度 (TEMP.)	$-25\pm 3^\circ\text{C}$	$20\pm 2^\circ\text{C}$	$125\pm 3^\circ\text{C}$	$20\pm 2^\circ\text{C}$
			時間 (TIME)	$30\pm 3\text{min.}$	3min. max	$30\pm 3\text{min.}$	3min. max
18. 耐濕性 Humidity (Under Steady State)	外觀 Appearance	無顯著異常 No marked defect	電容器在溫度 $40\pm 2^\circ\text{C}$, 濕度 $95\pm 3\% \text{RH}$ 下放置 500 ± 12 小時。 試驗前: 電容器應放置在 $125\pm 2^\circ\text{C}$ 的溫度下 1 小時, 然後在常溫下恢復 24 ± 2 小時後測試。 試驗後: 在室內條件下恢復 24 ± 2 小時測試。 Set the capacitor for 500 ± 12 hours at $40\pm 2^\circ\text{C}$ in $95\pm 3\% \text{RH}$. pre-treatment: The capacitor shall be placed at $125\pm 2^\circ\text{C}$ for 1 hour, then placed at room condition for 24 ± 2 hours before measurement. Post-treatment: The capacitor shall be stored for 24 ± 2 hours at room condition before measurement.				
	容量變化 Capacitance Change	B: $\pm 10\%$ max E: $\pm 20\%$ max					
	損耗因數 D.F.	B, E: 5.0% Max					
	絕緣電阻 I.R.	$1500\text{M}\Omega$ min					
	抗電強度 Dielectric Strength	按第八條。 Per Item 8					
19. 壽命試驗 Life Test	外觀 Appearance	無顯著異常 No marked defect	脈衝電壓 進行壽命試驗前, 每只電容器應接受 8kV 電壓衝擊 3 次 電容器在 $125\pm 2^\circ\text{C}$, 濕度 50% max 條件下, 放置 1000 小時, 並施加 680VAC (r.m.s) $<50/60\text{Hz}>$ 交流工頻電壓, 每小時升高到 1000V . AC (r.m.s) 持續 0.1 秒。 試驗後: 在室內條件下恢復 24 ± 2 小時。 Impulse voltage Each individual capacitor should be subjected to a 8kV impulses for three times. Then the capacitors are applied to life test. Apply a voltage of 680VAC (r.m.s) $<50/60\text{Hz}>$ alternating voltage of mains frequency, except that once each hour the voltage is increased to 1000V . AC (r.m.s) for 0.1sec . that shall be maintained for 1000 hours at $125\pm 2/-0^\circ\text{C}$ and relative humidity of 50% max. Post-treatment: Capacitor shall be stored for 24 ± 2 hours at room condition.				
	容量變化 Capacitance Change	B: $\pm 10\%$ max E: $\pm 20\%$ max					
	損耗因數 D.F.	B, E: 5.0% Max					
	絕緣電阻 I.R.	$1500\text{M}\Omega$ min					
	抗電強度 Dielectric Strength	按第八條。 Per Item 8					
20. 放電試驗 Discharge Test	外觀 Appearance	無顯著異常 No marked defect	如圖, 由 Cd 經 Vs 充電後向被測電容 Ct 放電, 充放電時間均為 5 秒, 一共 50 次。 As in figure, discharge is made 50 times at 5sec . intervals from the capacitor (Cd) charged at DC voltage of specified. Ct: 被測電容 Capacitor under test S: 高壓開關 High-voltage switch R1: 1000Ω R2: $4\text{M}\Omega$ R3: 浪湧電阻 Surge resistance Cd: 1nF Vs: 10KVDC				
	絕緣電阻 I.R.	大於 $1000\text{M}\Omega$ $1000\text{M}\Omega$ min					
	抗電強度 Dielectric Strength	按第八條。 Per Item 8					

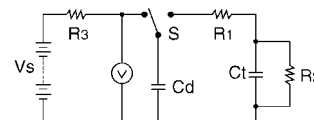
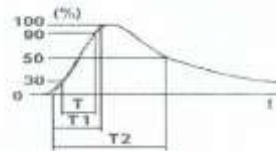

□瓷介電容器使用注意事項 Ceramic capacitor use matters needing attention :

1. 工作電壓 Operating voltage :

在交流電路或紋波電流電路中使用直流額定電壓電容器時, 請務必確保外加電壓的 V_{p-p} 值或包含直流偏置電壓的 V_{o-p} 值保持在額定電壓範圍內.

若向電路施加電壓, 開始或停止時可能會因諧振或切換產生暫時的不規則電壓. 請務必使用額定電壓範圍大於此不規則電壓的電容器.

Be sure to maintain the V_{p-p} value of the applied voltage or the V_{o-p} which contains DC bias within the rated voltage range.

When the voltage is started to apply to the circuit or it is stopped applying, the irregular voltage may be generated for a transit period because of resonance or switching. Be sure to use a capacitor within rated voltage containing this irregular voltage.

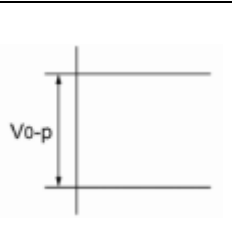
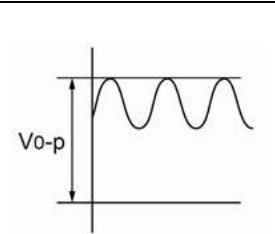
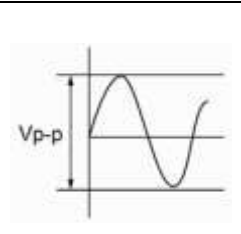
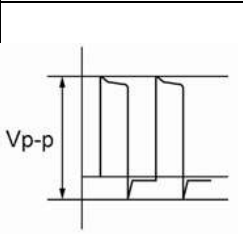
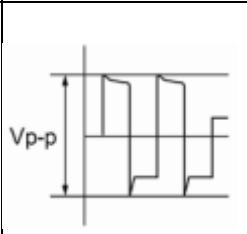
直流電壓 DC voltage	直流+交流電壓 DC+AC voltage	交流電壓 AC voltage	衝擊電壓 (1) Pulse voltage(1)	衝擊電壓 (2) Pulse voltage(2)
				

2. 工作溫度和自身發熱 Operating temperature and self-generated heat:

電容器的表面溫度應保持在其額定工作溫度範圍的上限以下. 務必考慮到電容器自身發出的熱量. 電容器在高頻電流、衝擊電流等中使用時可能會因介電損耗自身發熱. 所施加之正弦波電壓的頻率應低於300kHz. 外加電壓應使自身發熱等負荷在25°C周圍溫度條件下不超過20°C範圍. 測量時應使用 $\phi 0.1\text{mm}$ 小熱容量的 (K) 的熱電偶, 而且電容器不應受到其他元件的散熱或周圍溫度波動影響.

過熱可能會導致電容器特性及可靠性下降. (切勿在冷卻風扇運轉時進行測量, 否則無法確保測量資料的精確性.)

Keep the surface temperature of a capacitor below the upper limit of its rated operating temperature range. Be sure to take into account the heat generated by the capacitor itself. When the capacitor is used in a high-frequency current, pulse current or the like, it may have the self-generated heat due to dielectric-loss. Applied voltage should be the load such as self-generated heat is within 20°C on the condition of atmosphere temperature 25°C. When measuring, use a thermocouple of small thermal capacity-K of $\phi 0.1\text{mm}$ and be in the condition where capacitor is not affected by radiant heat of other components and wind of surroundings.

Excessive heat may lead to deterioration of the capacitor's characteristics and reliability. (Do not measure when the cooling fan is running, otherwise unable to ensure the accuracy of the measurement data.)

3. 耐電壓的測試條件 Test condition for withstanding voltage :

3.1 測試設備 Test equipment :

交流耐電壓的測試設備應具有能夠產生類似於50/60Hz正弦波的功能, 如果施加變形的正弦波或超過規定電壓值的超載電壓, 則可能會導致故障.

Test equipment for AC withstanding voltage shall be used with the performance of the wave similar to 50/60 Hz sine waves.

If the distorted sine wave or over load exceeding the specified voltage value is applied, the defective may be caused.

3.2 電壓外加方法Voltage applied method :

施加耐電壓時，電容器的引線或端子應與耐電壓測試設備的輸出端連接牢固，然後再將電壓從近零增加到測試電壓。

如果測試電壓不從近零逐漸提高而是直接施加在電容器上，則施加時應包含過零點*。測試結束時，測試電壓應降到近零，然後再將電容器引線或端子從耐電壓測試設備的輸出端取下。

如果測試電壓不從近零逐漸提高而是直接施加在電容器上，則可能會出現浪湧電壓，從而導致故障。

*過零點是指電壓正弦通過0V的位置。參見右圖：

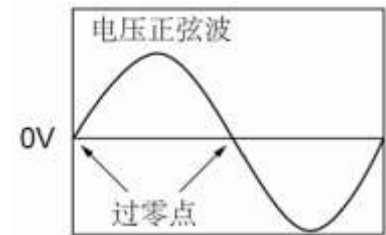

When the withstanding voltage is applied, capacitor's lead or terminal shall be firmly connected to the output of the withstanding voltage test equipment, and then the voltage shall be raised from near zero to the test voltage.

If the test voltage without the raise from near zero voltage would be applied directly to capacitor, test voltage should be applied with the *zero cross. At the end of the test time, the test voltage shall be reduced to near zero, and then capacitor's lead or terminal shall be taken off the output of the withstanding voltage test equipment.

If the test voltage without the raise from near zero voltage would be applied directly to capacitor, the surge voltage may arise, and therefore, the defective may be caused.

ZERO CROSS is the point where voltage sine wave pass 0V. - See the right figure.

4. 失效安全性Fail-Safe :

如果電容器破損，會導致短路電路故障。務必在本產品上適當提供例如保險絲等自動防故障功能，以免導致電擊、火災、或冒煙等。

When capacitor would be broken, failure may result in a short circuit. Be sure to provide an appropriate fail-safe function like a fuse on your product if failure would follow an electric shock, fire or fume.

5. 儲存環境Storage condition :

電容器的絕緣塗層不具有良好密封作用。因此，請勿將電容器存放在腐蝕性氣體中，尤其是存在氯氣、硫氣、酸、堿、鹽等的場所。同時應防潮。在對本產品進行清洗、覆膜或封膜前，請先在指定設備上測試經清洗、覆膜或封膜的產品的性能，以確定上述過程不會影響產品品質。電容器應存放在下列條件的場所：

環境溫度：-25℃——+50℃；相對濕度：40℃時不大於90%；氣壓：40——106KPA

請在6個月內使用電容器，若超期須重新提交檢驗。

使用本品時如忽略上述警告事項，則在嚴重情況下可能導致短路，並引起冒煙或局部離散。

The insulating coating of capacitors does not form a perfect seal; therefore, do not use or store capacitors in a corrosive atmosphere, especially where chloride gas, sulfide gas, acid, alkali, salt or the like are present. And avoid exposure to moisture. Before cleaning, bonding, or molding this product, verify that these processes do not affect product quality by testing the performance of a cleaned, bonded or molded product in the intended equipment. Capacitors should be stored in the following conditions:

The environment temperature : -25℃~+50℃; Relative humidity : 40 °C is not greater than 90%

Air pressure : 40~106KPA

Use capacitors within 6 months, If exceed the time limit need to submit inspection.

Failure to follow the above cautions may result, worst case, in a short circuit and cause fuming or partial dispersion when the product is used.

6. 焊接、安裝與使用Soldering、mounting and use:

6.1 振盪與衝擊Vibration and impact

使用時請勿使電容器或引線受到過度衝擊或振盪.

When using do not make the capacitor or lead by excessive impact or vibration.

6.2 焊接Soldering

將該產品焊接在PCB/PWB上時,不應超出電容器的耐焊接熱規格,本產品過熱會使內部接點錫焊料熔化,導致溫度驟變,從而造成陶瓷元件產生裂紋.

當使用烙鐵焊接電容器時,應遵循以下條件:

烙鐵頭溫度: 最高400°C;烙鐵功率: 最大50W;焊接時間: 最多3.5秒

When soldering this product to a PCB/PWB, do not exceed the solder heat resistance specification of the capacitor. Subjecting this product to excessive heating could melt the internal junction solder, Lead to temperature shock, Resulting in the ceramic element to produce crack.

When soldering capacitor with a soldering iron, it should be performed in following conditions:

Temperature of iron-tip: 400 degrees C. max.

Soldering iron wattage: 50W max.

Soldering time: 3.5 sec. max.

7. 清洗(超聲波清洗) Cleaning (ultrasonic cleaning):

進行超聲波清洗時,應遵守下列條件:

洗滌槽容量: 20瓦特輸出功率/每升或以下;洗滌時間: 最多5分鐘;

不得直接振盪PCB/PWB. 過度的超聲波洗滌會導致引線的超載損壞.

To perform ultrasonic cleaning, observe the following conditions.

Rinse bath capacity: Output of 20 watts per liter or less. Rinsing time: 5 minutes max.

Do not vibrate the PCB/PWB directly. Excessive ultrasonic cleaning may lead to fatigue destruction of the lead wires

運輸Transport :

電容器在運輸途中,要注意避免陽光直射,雨、雪、霧、水浸透等.

In transit, Capacitors should be avoided direct sunlight, rain, snow, fog, water soaked and so on.